

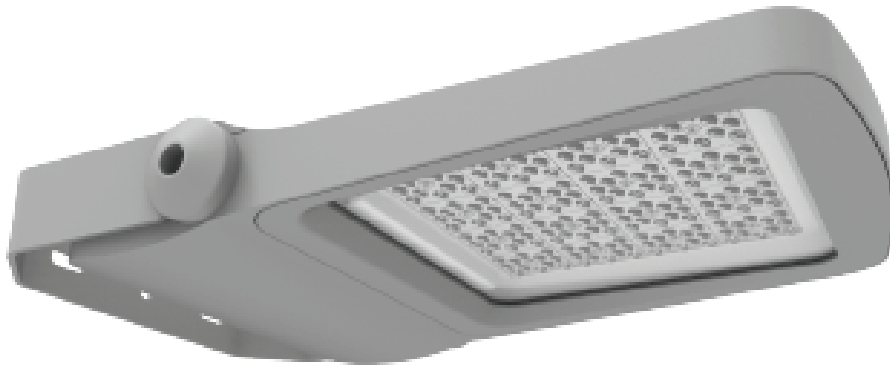

ELTON
LIGHTING

Lighting your ways..

ROCKER-NEO



IP66

CRI ≥80

CE

RoHS











ROCKER-NEO is ELTON's flood light is designed for recreational sports and area lighting with excellent performance and high protection level.

Application Areas

- > General Flood Lighting
- > High Mast Lighting
- > Sports Flood
- > Security Flood

Specifications

Picture	Power	Efficacy(IES)	Total Lumen	N.W	Product Dimensions
	30W	132LPW	3,960lm	3.5kg / 7.7lbs	320×224×50mm 12.6×8.8×2.0in
	50W	129LPW	6,450lm	3.5kg / 7.7lbs	320×224×50mm 12.6×8.8×2.0in
	70W	133LPW	9,310lm	5.2kg / 11.5lbs	421×291×62mm 16.6×11.5×2.4in
	100W	132LPW	13,200lm	5.2kg / 11.5lbs	421×291×62mm 16.6×11.5×2.4in
	150W	130LPW	19,500lm	12.2kg / 26.9lbs	520×342×65mm 20.5×13.5×2.6in
	200W	130LPW	26,000lm	12.2kg / 26.9lbs	520×342×65mm 20.5×13.5×2.6in
	300W	133LPW	39,900lm	14kg / 30.9lbs	620×450×84mm 24.4×17.7×3.3in
	400W	132LPW	52,800lm	14kg / 30.9lbs	620×450×84mm 24.4×17.7×3.3in

Product Dimensions

30W

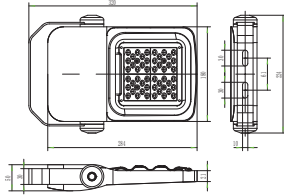

150W

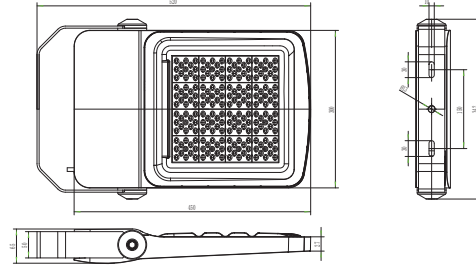

50W

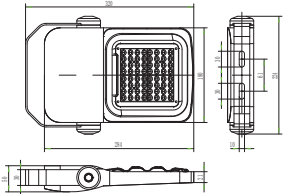

200W

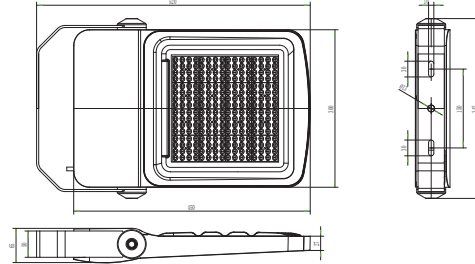

70W

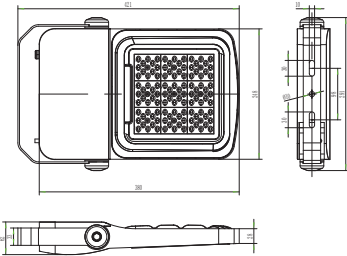

300W

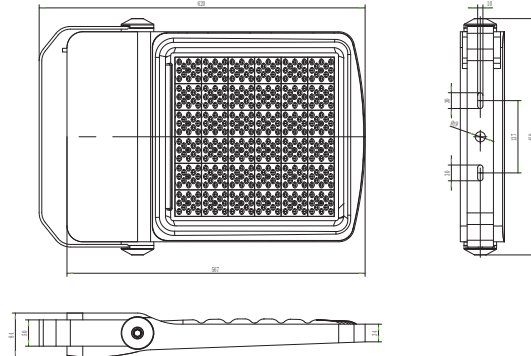

100W

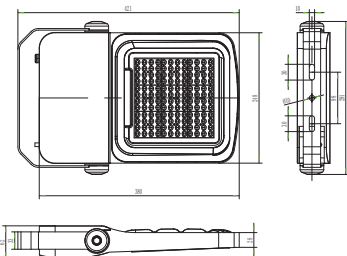

400W

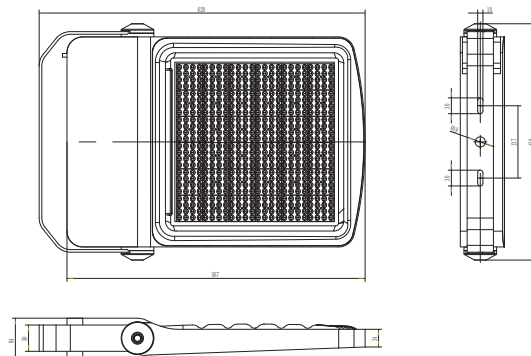

»»» **Photometrics**

30W / 70W / 150W / 300W

30 Degree Lens

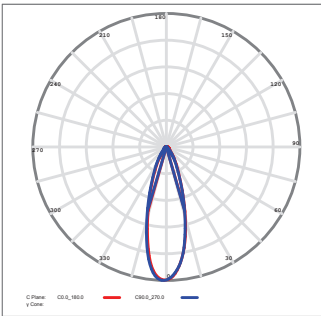

60 Degree Lens

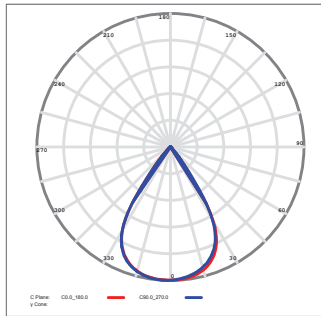

90 Degree Lens

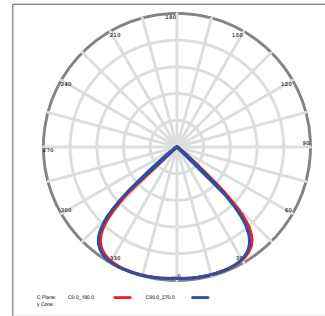

70x140 Degree Lens

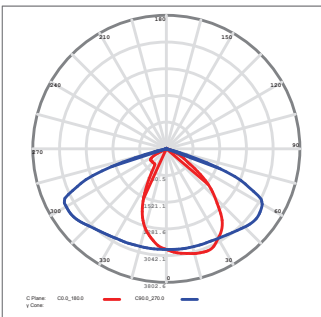

70x150 Degree Lens

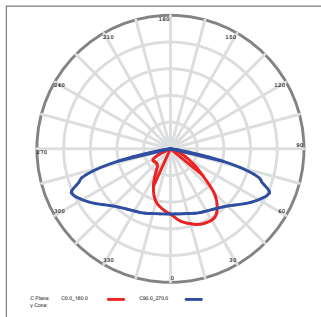

95x150 Degree Lens

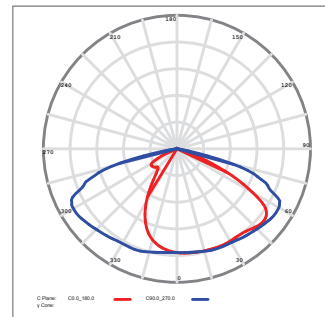

50W / 100W / 200W / 400W

25 Degree Lens

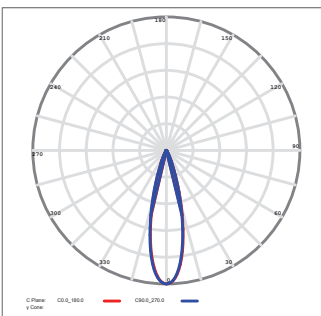

60 Degree Lens

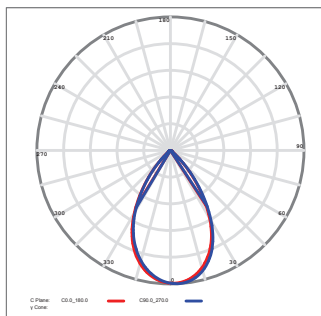

90 Degree Lens

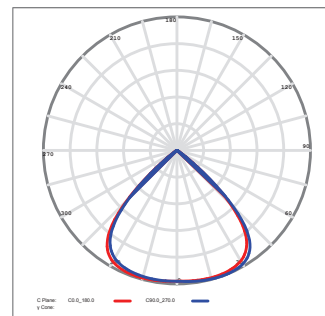

55x150 Degree Lens

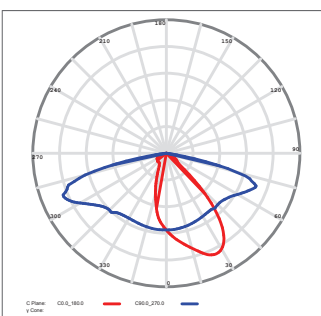

60x150 Degree Lens

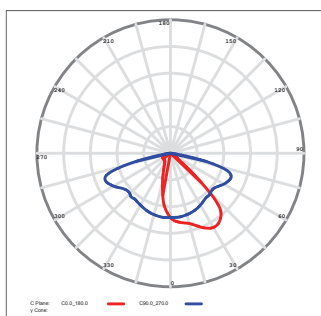

75x150 Degree Lens

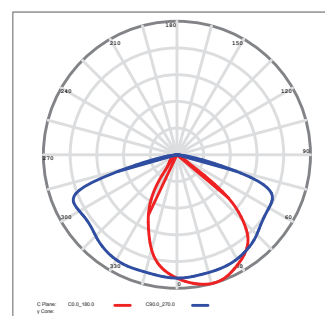

Parameters

AC Input Range	AC 100-277VAC
Input Frequency	50-60Hz
CRI	>70
LED Chip	Philips Lumileds
CCT Range	4500-5500K (2500K-6500K Optional)
Lumen Maintenance	L70>120,000 Hours
Power Factor)	0.95 Minimum
Working Temp.	-30 to +50 Degree
Storage Temp.	-40 to +80 Degree
Ingress Protection	IP66
LED Driver	Built -In
Humidity	15% to 95% RH
Fixture Material	Aluminum Alloy
Finish	RAL7045-Grey

Accessories

Image	Description
	Standard U Bracket

Ordering Info.

